

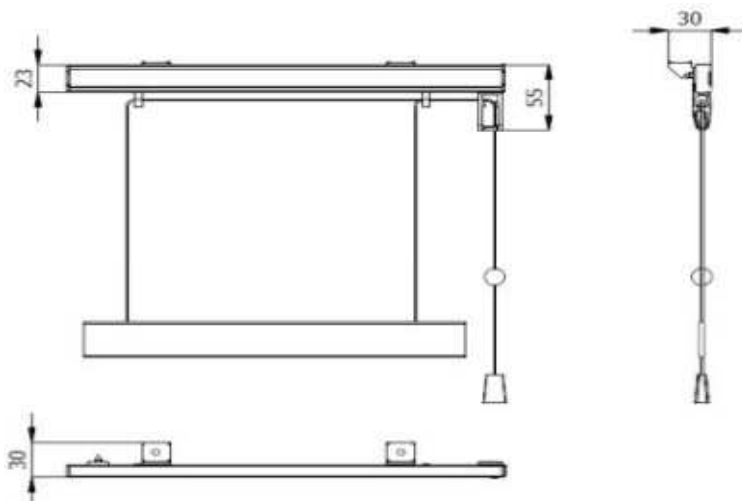







Sistema a pacchetto **Flash**  
applicazione a serramento

Componenti e ricambi



ARTICOLO	DESCRIZIONE	CODICE	QUANTITÀ	UNITÀ	PREZZO FrS
	Profilo velcrato bianco	DK.005.005	In barre 6 mt Al taglio	ml. ml.	
	Fermacorda rullino in ottone	DM.121.000	200	Conf.	
	Scendicorda sgancio rapido	DM.131.000	500	Conf.	
	Occhiello fissaggio fettuccia	DM.200.000	500	Conf.	
	Anellino a cucire trasparente	DM.201.002	1000	Conf.	
	Olivetta in plastica	DM.230.005	100	Conf.	
	Nappina	DM.235.005	100	Conf.	

	Cordina 1.2 mm Cordina 3.2 mm.	DK.225.000 DK.210.000	500 500	Conf. Conf.	
	Fettuccia con anellini yoyo 16 mm. bianco Fettuccia con anellini yoyo 16 mm. trasparente	B 016 L B 016 LT	100 100	Conf. Conf.	
	Fettuccia con asola Yoyo 16 mm. bianco Fettuccia con asola Yoyo 16 mm. trasparente	B 016 B 016 T	150 150	Conf. Conf.	
	Fettuccia con asola Yoyo 16 mm. da arricciare	B 016 V	100	Conf.	

Tenda a pacchetto **Guizzo**  
comando catenella

Componenti e ricambi

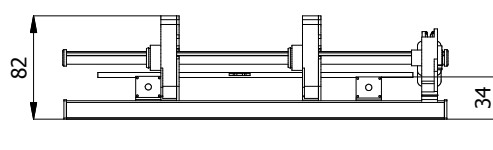
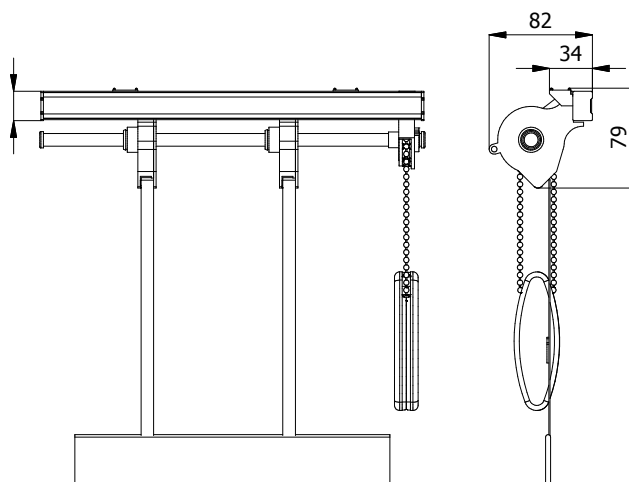



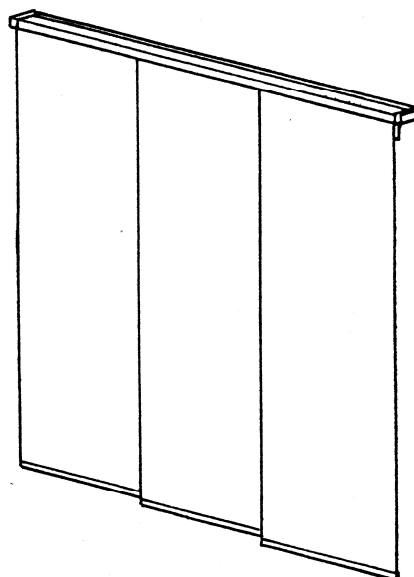





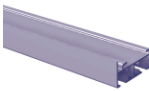
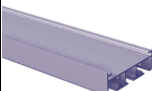
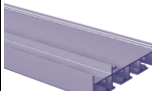
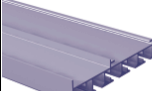
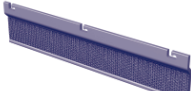

ARTICOLO	DESCRIZIONE	CODICE	QUANTITA	UNITÀ	PREZZO FrS
	Profilo velcrato bianco	DK.005.005	In barre 6 mt Al taglio	ml. ml.	
	Peso catena con inserto in metallo	DK.191.01B	50	Pz.	
	Comando catenella frizionato	DM.100.000	50	Conf.	
	Avvolginastro facile manutenzione	DM.110.100	100	Conf.	
	Fettuccia sollevamento 5 mm.	DM.220.000	150	Conf.	
	Catena comando passo 12 mm.	LP.087.1B	250	Conf.	

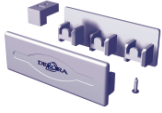
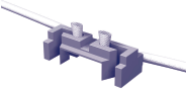
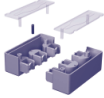
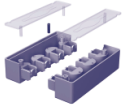
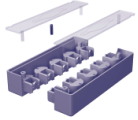

Sistema per tende a pannello **"Elite"**  
Liberi, uno tira l'altro, a corda

Componenti e ricambi

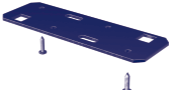





ARTICOLO	DESCRIZIONE	CODICE	QUANTITA'	U.M.	PREZZO
	Profilo 2 vie bianco	522.008.502	barre mt.6 al taglio	ml. ml.	
	Profilo 3 vie bianco	522.008.503	barre mt.6 al taglio	ml. ml.	
	Profilo 4 vie bianco	522.008.504	barre mt.5 al taglio	ml. ml.	
	Profilo 5 vie bianco	522.008.605	barre mt.6 al taglio	ml. ml.	
	Barra velcrata PVC	522.008.800	Barre mt.4 Al taglio	ml. ml.	
	Rullino tornito in delrin	522.008.601	250	Conf.	
	Traino a T	522.008.802	100	Conf.	
	Traino a L	522.008.803	100	Conf.	

	Chiavetta fissaggio a 2 vie	522.008.800	100	Conf.	
	Chiavetta fissaggio 3 – 4 - 5 vie	522.008.805	100	Conf.	
	Coppia tappi con ammortizzatore	522.008.706.2 522.008.706.3 522.008.706.4 522.008.706.5	20	Conf.	
	Giunzione per corda	522.008.702	50	Conf.	
	Coppia scendicorda 3 vie	522.008.703	20	Conf.	
	Coppia scendicorda 4 vie	522.008.704	20	Conf.	
	Coppia scendicorda 5 vie	522.008.705	20	Conf.	
	Giunzione binario 2 vie	522.008.900	10	Conf.	
	Giunzione binario 3 – 4 – 5 vie	522.008.901	10	Conf.	
	Fiocco peso corda	520.000.101	50	Conf.	

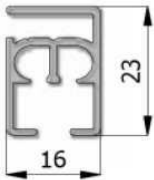
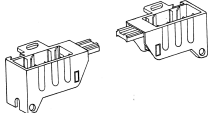
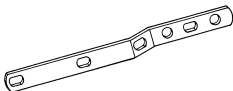







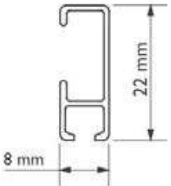

## Listino componenti sistemi per tende arricciate

### Componenti sistema Ronde



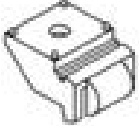



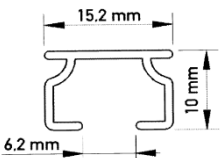

ARTICOLO	DESCRIZIONE	CODICE	CONFEZIONE	PREZZO
	<b>Profilo argento bianco</b>  In barre da 6 mt. Tagliato a misura	DK.020.010 DK.020.005		
	<b>Coppia guide</b>	DK.100.105	Cp. 50	
	<b>Asta di sormonto in metallo completa di carrello e giunzione corda</b>	DK.116.100	Pz. 50	
	<b>Supporto a soffitto</b>	DK.160.100	Pz. 100	
	<b>Supporto a parete</b>	DK.160.200	Pz. 100	
	<b>Scivolo rotante</b>	DK.147.000	Pz. 500	
	<b>Scorrevole con rullo</b>	LS.200.000	Pz. 500	
	<b>Scivolo largo in materozza</b>	DH.130.000	Pz. 500	
	<b>Giunzione corda</b>	DK.130.100	Pz. 50	

## Listino componenti E 8010 Stabilo

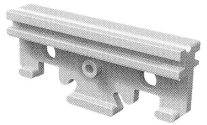
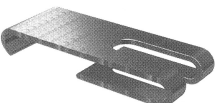



ARTICOLO	DESCRIZIONE	CODICE	CONFEZIONE	PREZZO
	<b>Profilo argento</b> <b>Profilo bianco</b>  In barre da mt. 6 Tagliato a misura	DK.010.002 DK.010.005		
	<b>Tappo laterale</b>	DK.186.005	Pz. 100	
	<b>Tappo con occhiolo</b>	DK.187.005	Cp. 100	
	<b>Raccordo angolare</b>	DK.180.105	Pz. 100	
	<b>Bottone a scomparsa</b>	DM.141.000	Pz. 100	
	<b>Carrello di sormonto in plastica</b>	DK.120.000	Pz. 50	
	<b>Supporto a soffitto</b>	DK.160.000	Pz. 100	
	<b>Supporto universale a chiavetta</b>  Lunghezza cm. 2 Lunghezza cm. 6	DK.175.000 DK.176.000	Pz. 100 Pz. 100	
	<b>Fermo a innesto con occhiolo</b>	DK.125.000	Pz. 100	
	<b>Scivolo canale stretto in materozza</b>	DK.145.000	Pz. 2000	



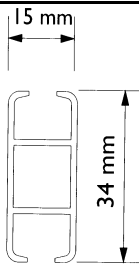
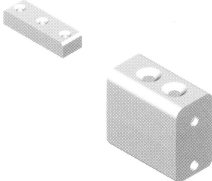
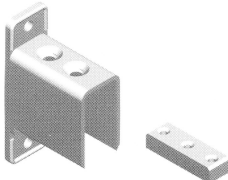

## Componenti sistema Mini

ARTICOLO	DESCRIZIONE	CODICE	CONFEZIONE	PREZZO
	<b>Profilo bianco</b> <b>In barre da 6 mt.</b> <b>Tagliato a misura</b>	<b>DH.001.005</b>		
	<b>Carrello di sormonto in metallo</b>	<b>DH.110.000</b>	<b>Pz. 50</b>	
	<b>Guida con rotelle</b>	<b>DH.105.000</b>	<b>Pz. 50</b>	
	<b>Carrello per apertura centrale</b>	<b>DH.125.000</b>	<b>Pz. 100</b>	
	<b>Supporto a soffitto bianco</b>	<b>DH.140.005</b>	<b>Pz. 100</b>	
	<b>Giunzione binario bianca</b>	<b>DH.145.005</b>	<b>Pz. 100</b>	
	<b>Scivolo largo in materozza</b>	<b>DH.130.000</b>	<b>Pz. 500</b>	
	<b>Tappo laterale</b>	<b>DH.135.000</b>	<b>Pz. 100</b>	

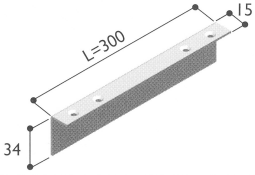
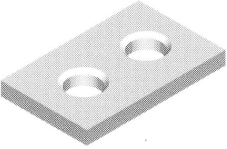

## Componenti sistema Box Separé

ARTICOLO	DESCRIZIONE	CODICE	CONFEZIONE	PREZZO
	<p><b>Profilo bianco</b></p> <p><b>In barre da 6 mt. Tagliato a misura</b></p>	<p><b>LS.001.585</b></p>		
	<p><b>Supporto a parete</b></p>	<p><b>LS.100.105</b></p>	<p><b>Pz. 10</b></p>	
	<p><b>Supporto a parete con flange</b></p>	<p><b>LS.120.105</b></p>	<p><b>Pz. 10</b></p>	
	<p><b>Scivolo con gancio metallo</b></p>	<p><b>LS.220.000</b></p>	<p><b>Pz. 100</b></p>	
	<p><b>Scivolo largo in materozza</b></p>	<p><b>DH.130.000</b></p>	<p><b>Pz. 500</b></p>	
	<p><b>Scivolo rotante</b></p>	<p><b>DK.147.000</b></p>	<p><b>Pz. 500</b></p>	

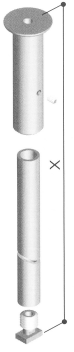
	<b>Vite di arresto</b>	<b>DP.325.000</b>	<b>Pz. 100</b>	
	<b>Piastra di congiunzione</b>	<b>LS.300.000</b>	<b>Pz. 10</b>	
	<b>Angolare di congiunzione</b>	<b>LS.320.000</b>	<b>Pz. 10</b>	
	<b>Ponte di congiunzione</b>	<b>LS.340.005</b>	<b>Pz. 5</b>	
	<b>Piastra di montaggio a soffitto</b>	<b>LS.345.005</b>	<b>Pz. 10</b>	
	<b>Tirante a V completo cm. 100</b>  <b>Tirante a V completo cm. 150</b>	<b>LS.390.105</b>  <b>LS.390.155</b>	<b>Pz. 1</b>  <b>Pz. 1</b>	
	<b>Tirante diritto cm. 100</b>  <b>Tirante diritto cm. 150</b>	<b>DK.230.105</b>  <b>DK.230.155</b>	<b>Pz. 10</b>  <b>Pz. 10</b>	